

富德 FG75

蓝牙3.0/蓝牙5.0/2.4G/有线三模机械游戏键盘
BT 3.0/BT 5.0/2.4G/Wired three mode mechanical gaming keyboard

使用说明
USER MANUAL

中文版:

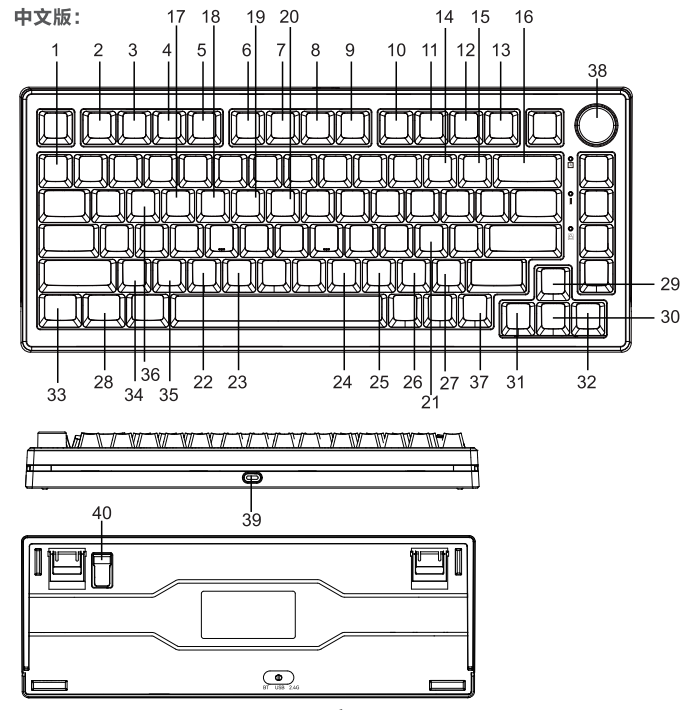

蓝牙模式连接:

1. 将开关拨动到BT处, 切换成功

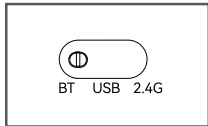

2. 长按Fn + E 键约3-5秒, 指示灯会快速闪烁, 则进入等待蓝牙配对。

如下以连接BT1为例:



3. 打开您的电脑或其他设备的蓝牙, 搜索和选择 "FG75 BT3.0"或"FG75 BT5.0"并开始蓝牙配对, 直到完成连接。

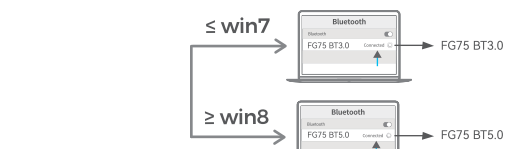

注意: 蓝牙模式兼容市面上大部分蓝牙 Dongle, 笔记本内置蓝牙模块, 蓝牙 5.0 则需要支持 WIN8 或以上系统, 平板及手机等

键盘模式切换方法

1. 模式通道: 键盘有5个通道, BT1、BT2、BT3、2.4G、有线, 可同时连接5个设备。
2. 模式切换: 拨动开关在有线/2.4G/BT之间切换, BT模式下按Fn + E、R 或 T, 可以在BT1、BT2、BT3切换不同蓝牙通道。

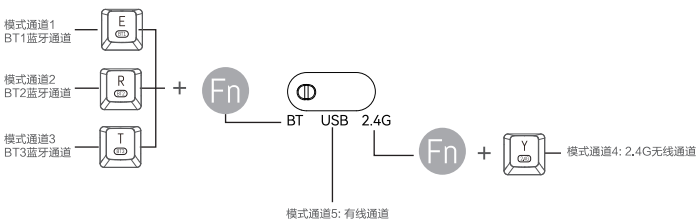

Mac/Win布局切换



注: 默认为Windows 键盘布局。

键盘功能概述: WIN/MAC/共用

- 1. + -: 恢复出厂设置
- 2. + F1: 我的电脑
- 3. + F2: 电子邮件
- 4. + F3: Win 搜索
- 5. + F4: 浏览器主页
- 6. + F5: 多媒体播放器
- 7. + F8: 播放/暂停
- 8. + F7: 上一曲
- 9. + F8: 下一曲
- 10. + F9: 无
- 11. + F10: 无
- 12. + F11: 无
- 13. + F12: 无
- 14. + -: 灯光速度-
- 15. + =: 灯光速度+
- 16. + Backspace: 查询电量
- 17. + E: 蓝牙模式1
- 18. + R: 蓝牙模式2
- 19. + T: 蓝牙模式3
- 20. + Y: 2.4G 模式
- 21. + L: 灯光关闭/开启
- 22. + C: 计算器
- 23. + V: 切换系统 Win/Mac
- 24. + M: 静音
- 25. + <: 音量-
- 26. + >: 音量+
- 27. + /: 切换灯光
- 28. + L_Win : 锁 Win
- 29. + T: 灯光亮度+
- 30. + L: 灯光亮度-
- 31. + <: 灯光方向←
- 32. + >: 灯光方向→
- 33. + L_Ctrl : 侧边灯光模式切换
- 34. + Z: 侧边灯光亮度切换
- 35. + X: 侧边灯光速度切换
- 36. + W、A、S、D 和方向键互换
- 37. + R_Ctrl : 长按 3s 切换成菜单键(可记忆),再长按切回
- 38. 逆时针功能: 音量-, 侧键为: 音量-, 按下中键后改变功能为: 逆时针功能: 背光亮度-, 侧键为: 背光亮度+。
- 39. Type-C充电有线接口
- 40. 2.4G接收器

充电指导:

1. 低电压提醒: 红灯慢闪指示当前为低电压状态

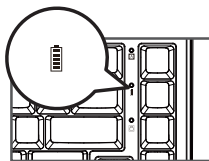

2. 充电线TYPE-C接口插入键盘, USB接口连接到您的电脑开始充电, 红色指示灯常亮指示正在充电

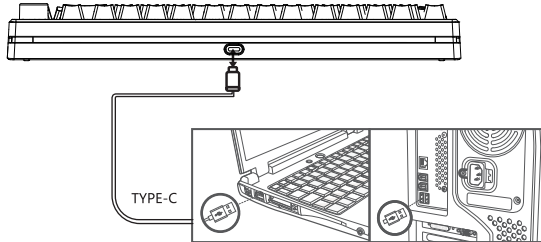

3. 充电完成 显示绿灯常亮/恢复正常背光。

有线模式连接:

1. 充电线TYPE-C接口插入键盘, USB接口连接到您的电脑。

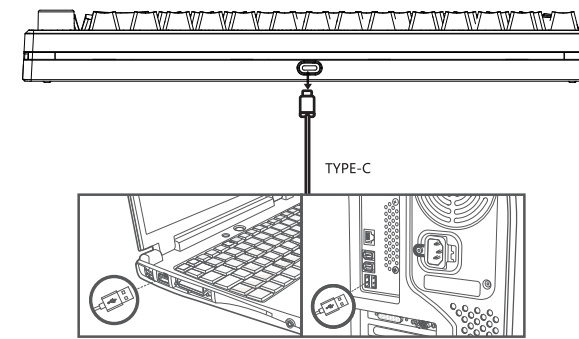

2. 将开关拨动到USB处, 切换成功完成连接

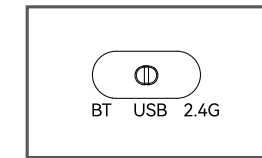

自定义驱动

自定义模式请扫描下方二维码官方驱动程序:
www.szforter.com



温馨提示: 驱动程序仅支持有线和2.4G模式下自定义。

技术规格

- 连接方式: 有线 / 2.4GHz / 蓝牙3.0 / 蓝牙5.0
- 无线有效距离: 约10米
- 工作电压: 3.7V
- 有线工作电流: 152mA
- 2.4G工作电流: 248mA
- BT工作电流: 241mA
- 键盘按键数: 82
- 键帽材质: ABS
- 机械轴寿命: 5000万次
- 锂电池: 2500mAh
- 键盘产品尺寸: 334x144.5x42mm
- 重量: 840g ± 10g

系统要求

- 1 x USB接口
 - 蓝牙3.0/蓝牙5.0
 - Windows® 7,Windows® 8,Windows® 10或更高版本, Android 3.2或更高版本, Mac OS 10.5或更高版本
- 注意: 不同系统版本中的多媒体功能会有部分无效。

故障排除

- 确保将产品的USB 无线接收器正确插入到电脑的USB接口。
- 确保电脑满足最低系统要求。
- 产品和无线接收器超出有效连接距离, 请减少产品和接收器之间的距离。

注意

- 清洁产品请使用干燥、柔软的棉织品等。
- 不要拆卸本产品。
- 不要强行拆卸本产品。
- 不要滥用或篡改或火灾。
- 不要直接用水冲洗。

2.4G模式连接:

1. 取出接收器, 插入接收器到电脑USB接口。

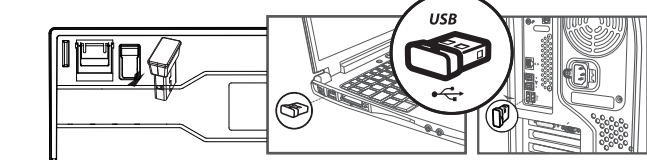

2. 将开关拨动到2.4G处, 切换成功完成连接

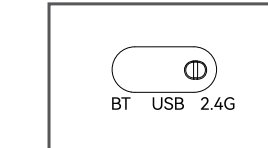

轴体更换方法:

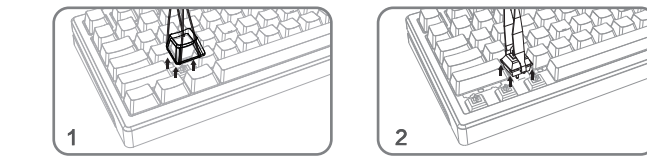

1. 用拔键器取下键帽。

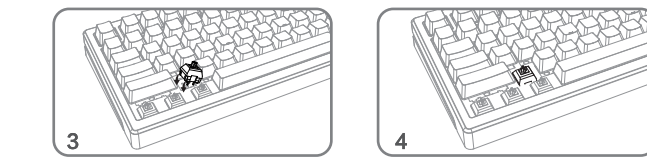

2. 用轴体将轴体拔出。

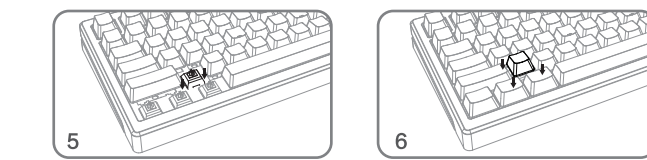

3. 将要换的轴体对安装位置, 对齐孔位。



4. 将新轴体放在卡位上。

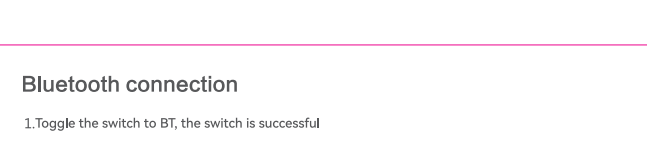

5. 轻按轴体装入卡位内。

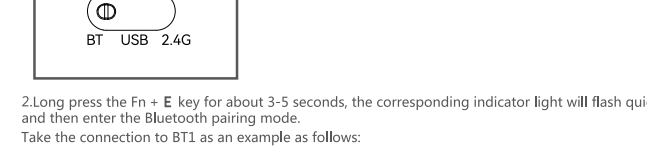

6. 装上键帽, 即可正常使用。

English:

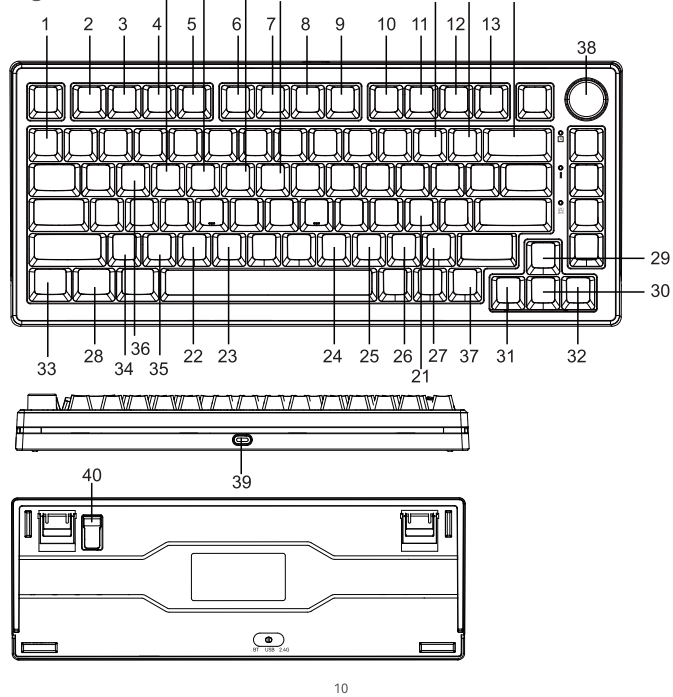

Function overview of the keyboard WIN/MAC/Communal

- 1. + -: Reset
- 2. + F1: My computer
- 3. + F2: Electronic mail
- 4. + F3: Win search
- 5. + F4: Browser home page
- 6. + F5: Media player
- 7. + F8: Pause/play
- 8. + F7: Prev song
- 9. + F8: Next song
- 10. + F9: null
- 11. + F10: null
- 12. + F11: null
- 13. + F12: null
- 14. + -: Light speed-
- 15. + =: Light speed+
- 16. + Backspace: Query battery
- 17. + E: Bluetooth 1
- 18. + R: Bluetooth 2
- 19. + T: Bluetooth 3
- 20. + Y: 2.4G Mode
- 21. + L: Lights on/off
- 22. + C: Calculator
- 23. + V: 切换系统 Win/Mac
- 24. + M: Mute
- 25. + <: volume -
- 26. + >: volume +
- 27. + /: Toggle lamp/light
- 28. + L_Win : Lock Win
- 29. + T: Light intensity +
- 30. + L: Light intensity -
- 31. + <: Light direction ←
- 32. + >: Light direction →
- 33. + L_Ctrl : Side light mode switch
- 34. + Z: Side light brightness switch
- 35. + X: Side light speed switch
- 36. + W、A、S、D And arrow keys
- 37. + R_Ctrl : Press and hold 3s to switch to the menu key (memorizable), and then press and hold back
- 38. Counterclockwise: volume -, clockwise: volume + After the middle key is pressed, the change function is as follows: Counterclockwise: backlight brightness -, clockwise: backlight brightness +.
- 39. Type-C charging/Wired interface
- 40. 2.4G Receiver

Wired connection

1. Insert the TYPE-C interface of the charging cable into the keyboard, and connect the USB interface to your computer.

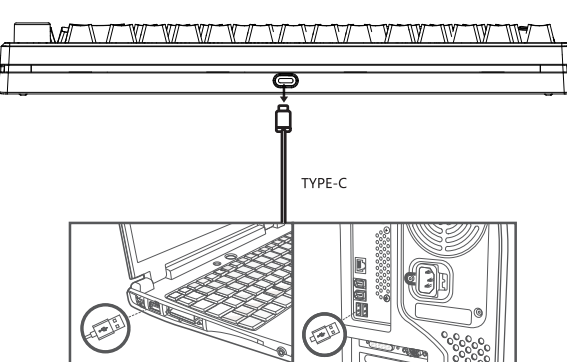

2. Toggle the switch to the USB, the switch successfully completed the connection

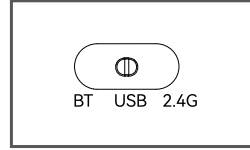

2.4G connection

1. Take out the receiver and insert the receiver into the USB port of the computer.

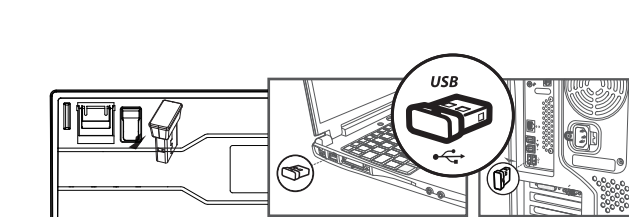

2. Toggle the switch to 2.4G, the switch successfully completed the connection

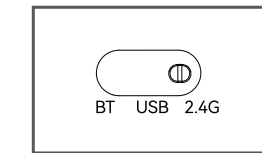

Bluetooth connection

1. Toggle the switch to BT, the switch is successful

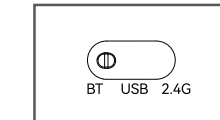

2. Long press the Fn + E key for about 3-5 seconds, the corresponding indicator light will flash quickly, and then enter the Bluetooth pairing mode. Take the connection to BT1 as an example as follows:



3. Turn on the Bluetooth of your computer or other device, search and select "FG75 BT3.0" or "FG75 BT5.0" and start Bluetooth pairing until the connection is completed.

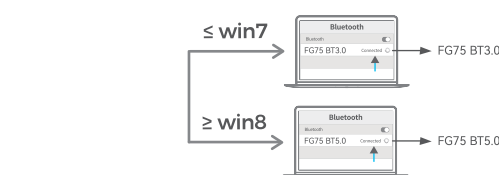

Notes: Bluetooth mode compatible with most of the market Bluetooth Dongle, laptop built-in Bluetooth module, Bluetooth 5.0 needs to support WIN8 or above systems, tablets and mobile phones

Mode switching method of the keyboard

1. Mode channel: The keyboard has 5 channels, BT1、BT2、BT3、2.4G、有线, and 5 devices can be connected at the same time。
2. Mode switch: toggle switch between wired /2.4G/BT. Press Fn +E、R、 or T in BT mode to switch between different Bluetooth channels in BT1, BT2, and BT3.

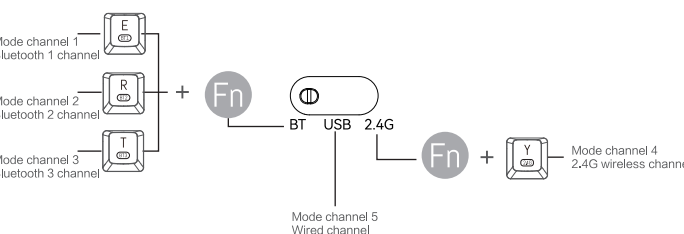

Mac/Win layout switching



Note: the default setting is Windows layout.

Charging guide:

1. Low voltage warning: The red light blinking slowly indicates that the current power is low

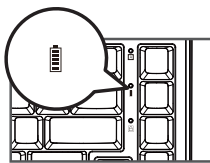

2. Plug the TYPE-C port of the charging cable into the keyboard, connect the USB port to your computer to start charging, and the red indicator light is steady on indicating that it is charging

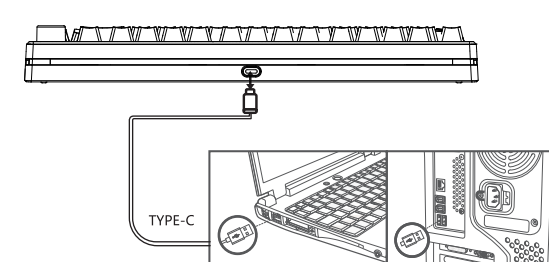

3. After charging is complete, the green light is steady on/normal backlight is restored.

Custom drive

For custom mode, please scan the code to download the official driver:
www.szforter.com
Reminder: The driver only supports customization in wired and 2.4G mode.

Technical specifications

- Connection method: wired / 2.4GHz / Bluetooth 3.0 / Bluetooth 5.0
- Wireless effective distance: about 10 meters
- Working current and voltage: 3.7V
- Wired operating current: 152mA
- 2.4G Working current: 248mA
- BT operating current: 241mA
- Keyboard Keys: 82
- Keypcap material: ABS
- Mechanical switch lifespan: 50 million times
- Lithium battery: 2500mAh
- Keyboard product size: 334x144.5x42mm
- Weight: 840g ± 10g

System requirement

- 1 x USB port
 - Bluetooth 3.0/Bluetooth 5.0
 - Windows® 7,Windows® 8,Windows® 10 or later, Android 3.2 and above, Mac OS 10.5 or later
- Note: Multimedia functions are partially invalid in different OS versions.

Trouble shooting

1. Make sure that the USB wireless receiver of the product is correctly plugged into the USB port of the computer.
2. Make sure the computer meets the minimum system requirement.
3. If the distance between the product and the receiver exceeds an effective range, please reduce the distance for better performance.

Attention

1. Please use dry and soft cloth to clean the product.
2. Do not disassemble the product by force.
3. Do not get in the rain or in the sun or fire.
4. Do not flush directly with water.

Shaft replacement method:

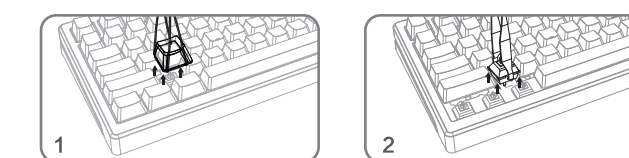

1. Use a keycap puller to unplug the key caps.

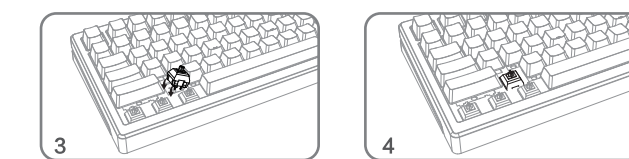

2. Check the installation position of the switch to be replaced and align the hole positions.

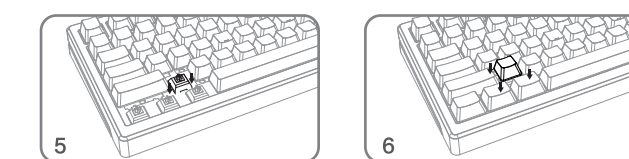

3. Gently press the new switch to install it into the slot.

4. Install the keycap, you can use it normally.



运营商: 东莞市正摩电子科技有限公司
Operator: Dongguan Zhengmo Electronic Technology Co. LTD
地址: 广东省东莞市南城街道心龙路8号4栋302室
Address: Room 302 Building 4, No. 8 Xinglong Road, Nanyang Town, Dongguan City, Guangdong
Service Tel: +86-400-915-2528 Web: www.szforter.com
键盘执行标准号: Keyboard Executive Standards: GB/T 14081-2010
Made in China
Company website:



请回收